

Hamamatsu Part Number	Andon Part Number	FIG. NO.	PIN QTY.	A	B	C	D
G8050-256R	IS229-828-88S-R29-L14	1	28	.802 [20.37]	1.300 [33.02]	.899 [22.83]	1.397 [35.48]
G8050-256S	IS229-828-88S-R29-L14	1	28	.802 [20.37]	1.300 [33.02]	.899 [22.83]	1.397 [35.48]
G8051-512R	IS229-828-88S-R29-L14	1	28	.802 [20.37]	1.300 [33.02]	.899 [22.83]	1.397 [35.48]
G8051-512S	IS229-828-88S-R29-L14	1	28	.802 [20.37]	1.300 [33.02]	.899 [22.83]	1.397 [35.48]
G8052-256R	IS229-828-88S-R29-L14	1	28	.802 [20.37]	1.300 [33.02]	.899 [22.83]	1.397 [35.48]
G8052-256S	IS229-828-88S-R29-L14	1	28	.802 [20.37]	1.300 [33.02]	.899 [22.83]	1.397 [35.48]
G8053-512R	IS229-828-88S-R29-L14	1	28	.802 [20.37]	1.300 [33.02]	.899 [22.83]	1.397 [35.48]
G8053-512S	IS229-828-88S-R29-L14	1	28	.802 [20.37]	1.300 [33.02]	.899 [22.83]	1.397 [35.48]
G8160-265S	IS229-828-88S-R29-L14	1	28	.802 [20.37]	1.300 [33.02]	.899 [22.83]	1.397 [35.48]
G8161-512S	IS229-828-88S-R29-L14	1	28	.802 [20.37]	1.300 [33.02]	.899 [22.83]	1.397 [35.48]
G8162-256S	IS229-828-88S-R29-L14	1	28	.802 [20.37]	1.300 [33.02]	.899 [22.83]	1.397 [35.48]
G8163-512S	IS229-828-88S-R29-L14	1	28	.802 [20.37]	1.300 [33.02]	.899 [22.83]	1.397 [35.48]
G8180-256W	IS229-828-88S-R29-L14	1	28	.802 [20.37]	1.300 [33.02]	.899 [22.83]	1.397 [35.48]
S7010-0906	IS229-424-80S-R29-L14	3	24	.400 [10.16]	1.100 [27.94]	.497 [12.62]	1.197 [30.40]
S7010-0907	IS229-424-80S-R29-L14	3	24	.400 [10.16]	1.100 [27.94]	.497 [12.62]	1.197 [30.40]
S7010-0908	IS229-624-80S-R29-L14	4	24	.600 [15.24]	1.100 [27.94]	.697 [17.70]	1.197 [30.40]
S7010-1006	IS229-424-80S-R29-L14	3	24	.400 [10.16]	1.100 [27.94]	.497 [12.62]	1.197 [30.40]
S7010-1007	IS229-424-80S-R29-L14	3	24	.400 [10.16]	1.100 [27.94]	.497 [12.62]	1.197 [30.40]
S7010-1008	IS229-624-80S-R29-L14	4	24	.600 [15.24]	1.100 [27.94]	.697 [17.70]	1.197 [30.40]
S7011-0906	IS229-624-80S-R29-L14	4	24	.600 [15.24]	1.100 [27.94]	.697 [17.70]	1.197 [30.40]
S7011-0907	IS229-624-80S-R29-L14	4	24	.600 [15.24]	1.100 [27.94]	.697 [17.70]	1.197 [30.40]
S7011-1006	IS229-624-80S-R29-L14	4	24	.600 [15.24]	1.100 [27.94]	.697 [17.70]	1.197 [30.40]
S7011-1007	IS229-624-80S-R29-L14	4	24	.600 [15.24]	1.100 [27.94]	.697 [17.70]	1.197 [30.40]
S7015-0908	IS229-9124-80S-R29-L14	5	24	.910 [23.11]	1.100 [27.94]	1.007 [25.58]	1.197 [30.40]
S7015-1008	IS229-9124-80S-R29-L14	5	24	.910 [23.11]	1.100 [27.94]	1.007 [25.58]	1.197 [30.40]
S7017-1007	IS229-2024-80S-R29-L14	6	24	2.000 [50.80]	1.100 [27.94]	2.097 [53.26]	1.197 [30.40]
S7017-1008	IS229-2024-80S-R29-L14	6	24	2.000 [50.80]	1.100 [27.94]	2.097 [53.26]	1.197 [30.40]
S7018-1010	575-13-83-048-01S-R29-L14	2	48	1.200 [30.48]	1.200 [30.48]	1.297 [32.94]	1.297 [32.94]
S7019-1009	575-13-83-048-01S-R29-L14	2	48	1.200 [30.48]	1.200 [30.48]	1.297 [32.94]	1.297 [32.94]
S7030-0906	IS229-924-01S-R29-L14	7	24	.900 [22.86]	1.100 [27.94]	.997 [25.32]	1.197 [30.40]
S7030-0907	IS229-924-01S-R29-L14	7	24	.900 [22.86]	1.100 [27.94]	.997 [25.32]	1.197 [30.40]
S7030-0908	IS229-924-01S-R29-L14	7	24	.900 [22.86]	1.100 [27.94]	.997 [25.32]	1.197 [30.40]
S7030-1006	IS229-924-01S-R29-L14	7	24	.900 [22.86]	1.100 [27.94]	.997 [25.32]	1.197 [30.40]
S7030-1007	IS229-924-01S-R29-L14	7	24	.900 [22.86]	1.100 [27.94]	.997 [25.32]	1.197 [30.40]
S7030-1008	IS229-924-01S-R29-L14	7	24	.900 [22.86]	1.100 [27.94]	.997 [25.32]	1.197 [30.40]
S7031-0906	IS229-924-01S-R29-L14	7	24	.900 [22.86]	1.100 [27.94]	.997 [25.32]	1.197 [30.40]
S7031-0907	IS229-924-01S-R29-L14	7	24	.900 [22.86]	1.100 [27.94]	.997 [25.32]	1.197 [30.40]
S7031-0908	IS229-924-01S-R29-L14	7	24	.900 [22.86]	1.100 [27.94]	.997 [25.32]	1.197 [30.40]
S7031-1006	IS229-924-01S-R29-L14	7	24	.900 [22.86]	1.100 [27.94]	.997 [25.32]	1.197 [30.40]
S7031-1007	IS229-924-01S-R29-L14	7	24	.900 [22.86]	1.100 [27.94]	.997 [25.32]	1.197 [30.40]
S7031-1008	IS229-924-01S-R29-L14	7	24	.900 [22.86]	1.100 [27.94]	.997 [25.32]	1.197 [30.40]
S7033-0907	IS229-924-01S-R29-L14	7	24	.900 [22.86]	1.100 [27.94]	.997 [25.32]	1.197 [30.40]
S7033-1007	IS229-924-01S-R29-L14	7	24	.900 [22.86]	1.100 [27.94]	.997 [25.32]	1.197 [30.40]
S7034-0907	IS229-924-01S-R29-L14	7	24	.900 [22.86]	1.100 [27.94]	.997 [25.32]	1.197 [30.40]
S7034-1007	IS229-924-01S-R29-L14	7	24	.900 [22.86]	1.100 [27.94]	.997 [25.32]	1.197 [30.40]
S7170-0909	IS229-924-01S-R29-L14	7	24	.900 [22.86]	1.100 [27.94]	.997 [25.32]	1.197 [30.40]
S7171-0909	IS229-924-01S-R29-L14	7	24	.900 [22.86]	1.100 [27.94]	.997 [25.32]	1.197 [30.40]
S7847-1007	IS229-2024-80S-R29-L14	6	24	2.000 [50.80]	1.100 [27.94]	2.097 [53.26]	1.197 [30.40]
S7847-1008	IS229-2024-80S-R29-L14	6	24	2.000 [50.80]	1.100 [27.94]	2.097 [53.26]	1.197 [30.40]
S7986-01	IS229-924-01S-R29-L14	7	24	.900 [22.86]	1.100 [27.94]	.997 [25.32]	1.197 [30.40]
S7987-01	IS229-924-01S-R29-L14	7	24	.900 [22.86]	1.100 [27.94]	.997 [25.32]	1.197 [30.40]
S8380-128Q	IS229-422-01S-R29-L14	8	22	.400 [10.16]	1.000 [27.94]	.497 [12.62]	1.097 [30.40]
S8380-256Q	IS229-422-01S-R29-L14	8	22	.400 [10.16]	1.000 [27.94]	.497 [12.62]	1.097 [30.40]
S8380-512Q	IS229-422-01S-R29-L14	8	22	.400 [10.16]	1.000 [27.94]	.497 [12.62]	1.097 [30.40]
S8381-256Q	IS229-422-01S-R29-L14	8	22	.400 [10.16]	1.000 [27.94]	.497 [12.62]	1.097 [30.40]
S8381-512Q	IS229-422-01S-R29-L14	8	22	.400 [10.16]	1.000 [27.94]	.497 [12.62]	1.097 [30.40]
S8381-1024Q	IS229-422-01S-R29-L14	8	22	.400 [10.16]	1.000 [27.94]	.497 [12.62]	1.097 [30.40]

HAMAMATSU *Continued*

Image Sensor Socket Footprints

Units: in [mm]

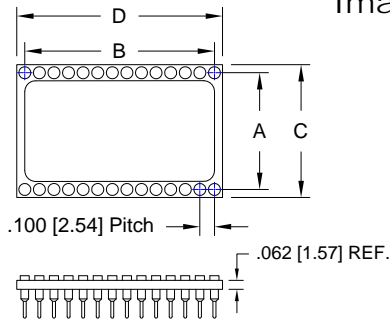

Fig. 1

Thru-Hole: IS229-828-88S-R29-L14
Surface Mount: IS229-828-XXX-R29-L14

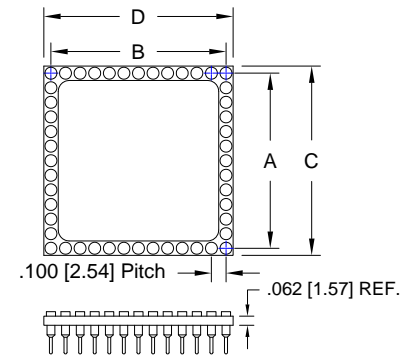

Fig. 2

Thru-Hole: 575-13-83-048-80S-R29-L14
Surface Mount: 575-13-83-048-XXX-R29-L14

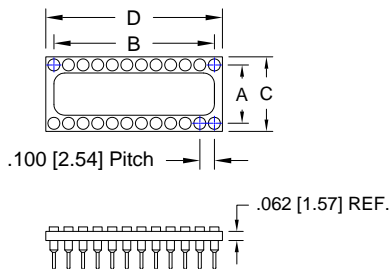

Fig. 3

Thru-Hole: IS229-424-80S-R29-L14
Surface Mount: IS229-424-XXX-R29-L14

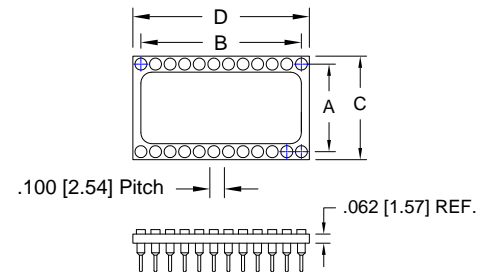

Fig. 4

Thru-Hole: IS229-624-80S-R29-L14
Surface Mount: IS229-624-XXX-R29-L14

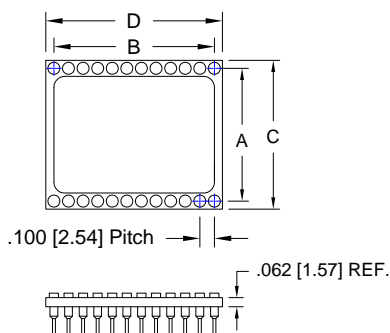

Fig. 5

Thru-Hole: IS229-9124-80S-R29-L14
Surface Mount: IS229-9124-XXX-R29-L14

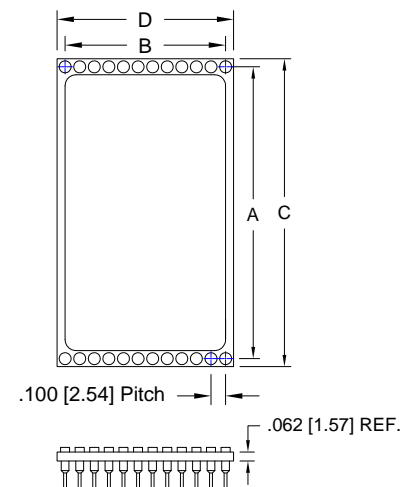

Fig. 6

Thru-Hole: IS229-2024-80S-R29-L14
Surface Mount: IS229-2024-XXX-R29-L14

HAMAMATSU *Continued*

Image Sensor Socket Footprints

Units: in [mm]

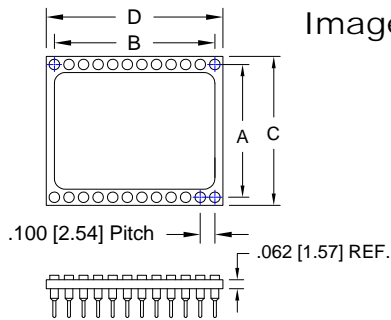

Fig. 7

Thru-Hole: IS229-924-01S-R29-L14
Surface Mount: IS229-924-XXX-R29-L14

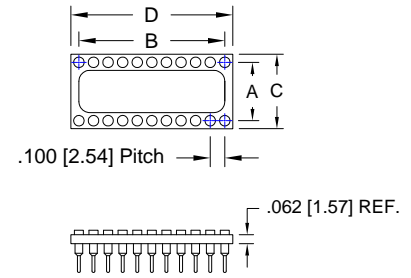
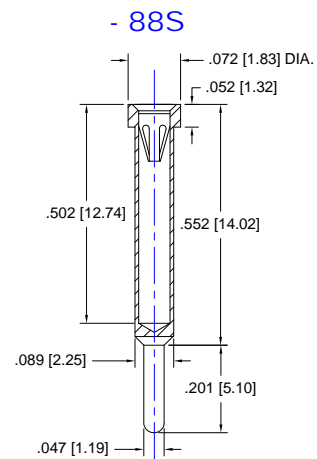
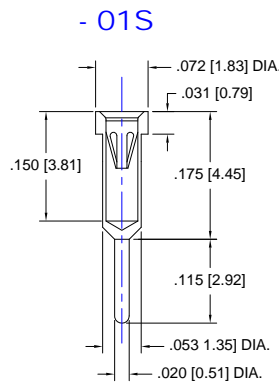
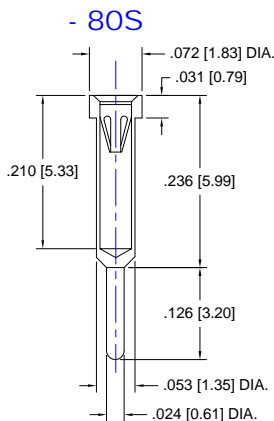

Fig. 8

Thru-Hole: IS229-422-01S-R29-L14
Surface Mount: IS229-422-XXX-R29-L14

Socket Terminal Details

Cross Section View Shown Units: in [mm]



TECHNICAL INFORMATION

Material:

Insulator: Hi-Temp UL94V-0
Terminal: Brass, per ASTM-B16
Contact: BeCu, per ASTM-B194

Standard Forces:

"M" Insertion: 1.6 oz. MAX. with .018 [0.46] Dia. Probe
Withdrawal: .5 oz. MIN. with .018 [0.46] Dia. Probe
"T" Insertion: 1.0 oz. MAX. with .010 [0.25] Dia. Probe
Withdrawal: 0.3 oz. MIN. with .010 [0.25] Dia. Probe
"T4" Insertion: 1.0 oz. MAX. with .011 [0.28] Dia. Probe
Withdrawal: 0.3 oz. MIN. with .011 [0.28] Dia. Probe

Standard Plating:

R27 Terminal: Gold **R29 Terminal:** Tin
Contact: Gold **Contact:** Gold

MOUNTING OPTIONS

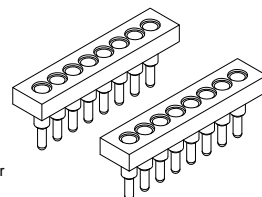
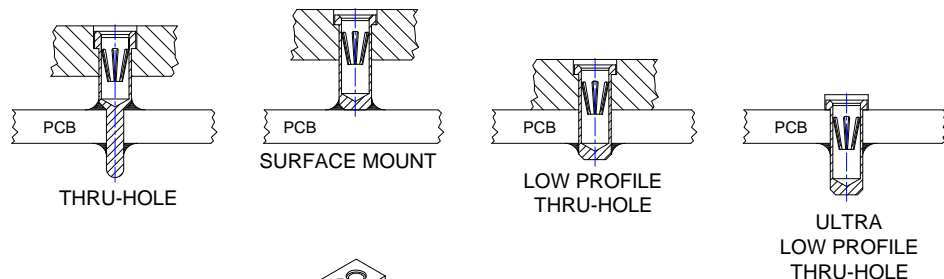

SIPS AVAILABLE
(CONTACT FACTORY)