

MERCURY UNITED ELECTRONICS, INC						
MERCURY UNITED ELECTRONICS, INC Model Number	Andon Part Number Replace "XXX" with Terminal Type	Terminal Type		Pin Ø [in]	Figure Number	Page Number
		Thru-Hole	Surface Mount			
U1	C075-03-03-01-XXX-R27-L14	400T4	414T4	.012	4	2
U5	C075-03-03-01-XXX-R27-L14	400T4	414T4	.012	4	2
HUS, HULS	C188-002-02-01-XXX-R27-L14	01S	93S	.018	1	1
S1	CSP291-04-02-XXX-R27-L14	400T4	414T4	.012	5	2
S2	CSP386-04-02-XXX-R27-L14	400T4	414T4	.012	6	2
H49	CSP192-02-02-XXX-R27-L14	433E	285E	.040	7	2
49T	CSP192-02-02-XXX-R27-L14	433E	285E	.040	7	2
HCK5761 SERIES	620D-06A-SM-G10-L14-1	-	-	-	16	4
HPK5761 SERIES	620D-06A-SM-G10-L14-1	-	-	-	16	4
HDK5761 SERIES	620D-06A-SM-G10-L14-1	-	-	-	16	4
PACKAGE G14	C10-314-04-01-XXX-R27-L14	01S	93S	.018	2	1
PACKAGE G8	C10-308-04-02-XXX-R27-L14	01S	93S	.018	3	1
T38	C043-002-02-01-XXX-R27-L14	400T4	414T4	.012	8	2
T15	C10-002-02-02-XXX-R27-L14	433E	285E	.040	10	2
PACKAGE OC22	C10-1514-07-02-XXX-R27-L14	295V	439V	.030	11	3
OC18E SERIES	C10-614-05-01-XXX-R27-L14	01S	93S	.018	12	3
OC11T	C10-7524-04-01-XXX-R27-L14	295V	439V	.030	13	3
PACKAGE H8	C10-308-04-03-XXX-R27-L14	01S	93S	.018	9	2
OC40	C10-1020-04-02-XXX-R27-L14	433E	285E	.040	14	3
HM8	C10-308-04-03-XXX-R27-L14	01S	93S	.018	9	2
HM57	606D-04A-SM-G10-L14-1	-	-	-	15	4
H575	606D-04A-SM-G10-L14-1	-	-	-	15	4

(FIG.1) MERCURY UNITED, INC.	ANDON PART NUMBER
	THRU-HOLE: C188-002-02-01-01S-R27-L14
	SURFACE MOUNT: C188-002-02-01-93S-R27-L14

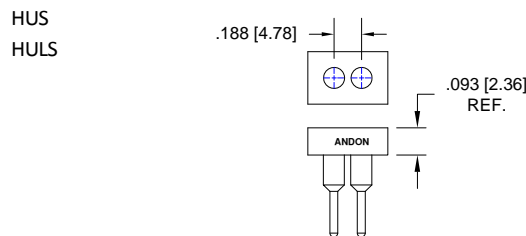

(FIG.2) MERCURY UNITED ELECTRONICS, INC.	ANDON PART NUMBER
	THRU-HOLE: C10-314-04-01-01S-R27-L14
	SURFACE MOUNT: C10-314-04-01-93S-R27-L14

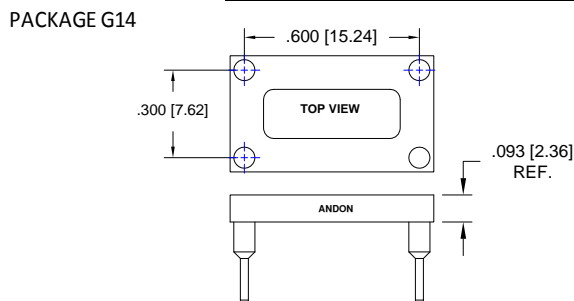

(FIG.3) MERCURY UNITED ELECTRONICS, INC.	ANDON PART NUMBER
	THRU-HOLE: C10-308-04-02-01S-R27-L14
	SURFACE MOUNT: C10-308-04-02-93S-R27-L14

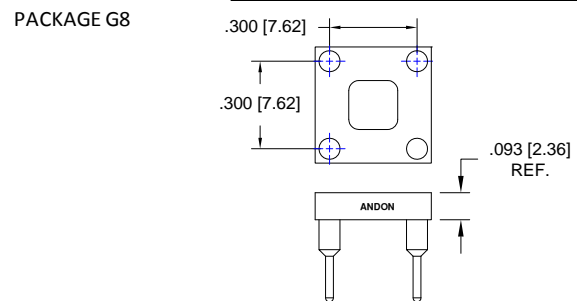

MERCURY UNITED ELECTRONICS, INC. *Continued*

(FIG.4) MERCURY UNITED ELECTRONICS, INC.	ANDON PART NUMBER
	THRU-HOLE: C075-03-03-01-400T4-R27-L14 SURFACE MOUNT: C075-03-03-01-414T4-R27-L14

U1
U5

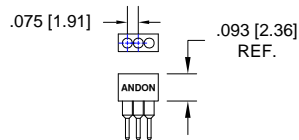

(FIG.5) MERCURY UNITED ELECTRONICS, INC.	ANDON PART NUMBER
	THRU-HOLE: CSP291-04-02-400T4-R27-L14 SURFACE MOUNT: CSP291-04-02-414T4-R27-L14

S1

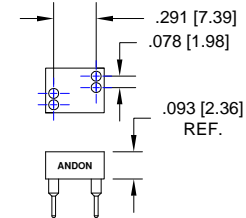

(FIG.6) MERCURY UNITED ELECTRONICS, INC.	ANDON PART NUMBER
	THRU-HOLE: CSP386-04-02-400T4-R27-L14 SURFACE MOUNT: CSP386-04-02-414T4-R27-L14

S2

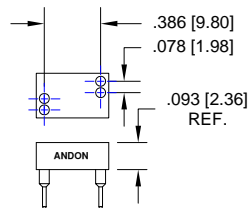

(FIG.7) MERCURY UNITED ELECTRONICS, INC.	ANDON PART NUMBER
	THRU-HOLE: CSP192-02-02-433E-R27-L14 SURFACE MOUNT: CSP192-02-02-285E-R27-L14

H49
49T

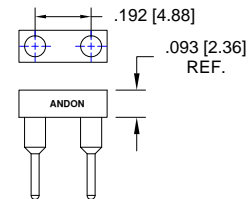

(FIG.8) MERCURY UNITED ELECTRONICS, INC.	ANDON PART NUMBER
	THRU-HOLE: C043-002-02-01-400T4-R27-L14 SURFACE MOUNT: C043-002-02-01-414T4-R27-L14

T38

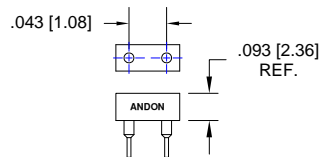

(FIG.9) MERCURY UNITED ELECTRONICS, INC.	ANDON PART NUMBER
	THRU-HOLE: C10-308-04-03-01S-R27-L14 SURFACE MOUNT: C10-308-04-03-93S-R27-L14

PACKAGE H8
HM8

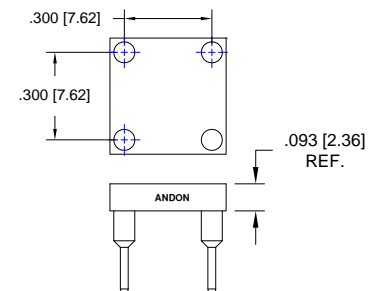

(FIG.10) MERCURY UNITED ELECTRONICS, INC.	ANDON PART NUMBER
	THRU-HOLE: C10-002-02-02-433E-R27-L14 SURFACE MOUNT: C10-002-02-02-285E-R27-L14

T15

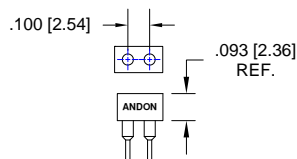

MERCURY UNITED ELECTRONICS, INC. Continued

(FIG.11) MERCURY UNITED ELECTRONICS, INC.	ANDON PART NUMBER
	THRU-HOLE: C10-1514-07-02-295V-R27-L14 SURFACE MOUNT: C10-1514-07-02-439V-R27-L14

PACKAGE OC22

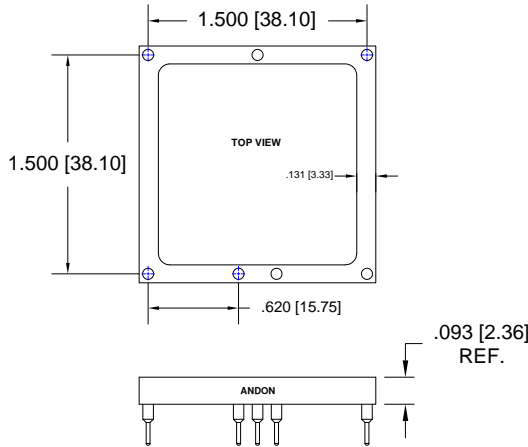

(FIG.12) MERCURY UNITED ELECTRONICS, INC.	ANDON PART NUMBER
	THRU-HOLE: C10-614-05-01-01S-R27-L14 SURFACE MOUNT: C10-614-05-01-93S-R27-L14

OC18E SERIES

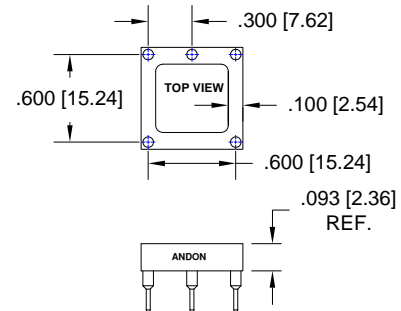

(FIG.13) MERCURY UNITED ELECTRONICS, INC.	ANDON PART NUMBER
	THRU-HOLE: C10-7524-04-01-01S-R27-L14 SURFACE MOUNT: C10-7524-04-01-93S-R27-L14

OC11T

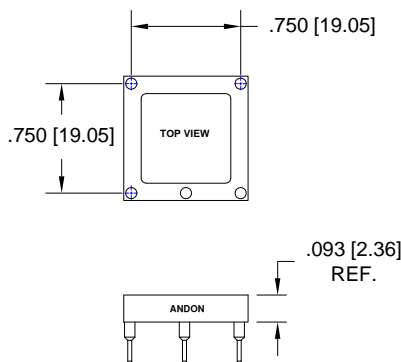

(FIG.14) MERCURY UNITED ELECTRONICS, INC.	ANDON PART NUMBER
	THRU-HOLE: C10-1020-04-02-433E-R27-L14 SURFACE MOUNT: C10-1020-04-02-285E-R27-L14

OC40

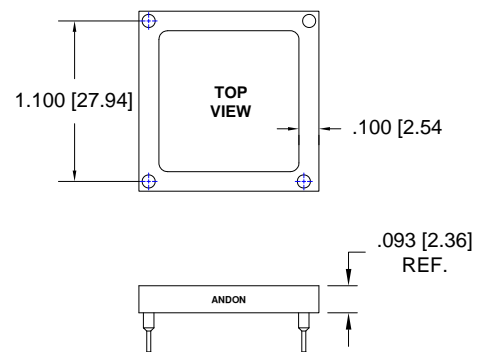

MERCURY UNITED ELECTRONICS, INC. *Continued*

(FIG.15) MERCURY UNITED ELECTRONICS, INC.	ANDON PART NUMBER
	THRU-HOLE: N/A SURFACE MOUNT: 606D-04A-SM-G10-L14-1

HM57
H575

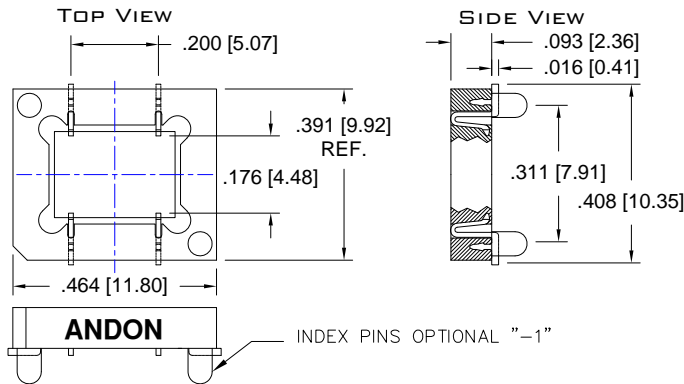

(FIG.16) MERCURY UNITED ELECTRONICS, INC.	ANDON PART NUMBER
	THRU-HOLE: N/A SURFACE MOUNT: 620D-06A-SM-G10-L14-1

HCK5761 SERIES
HPK5761 SERIES
HDK5761 SERIES

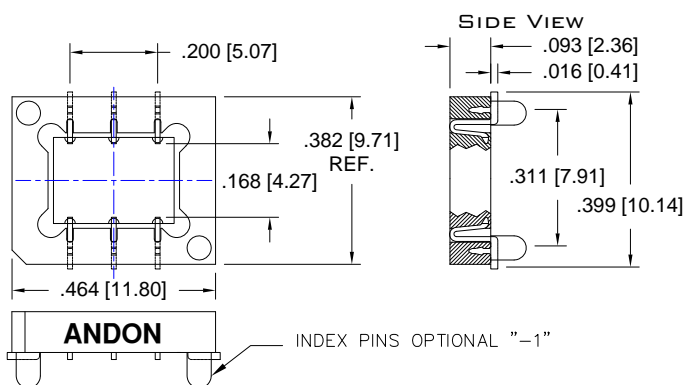

MERCURY UNITED ELECTRONICS, INC. *Continued*

Top View Shown
Units: in [mm]

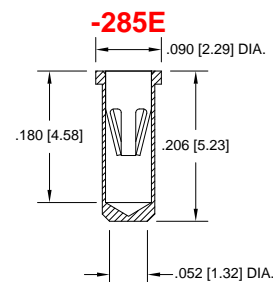
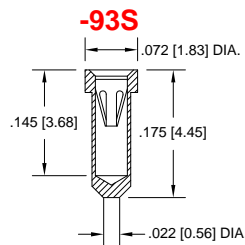
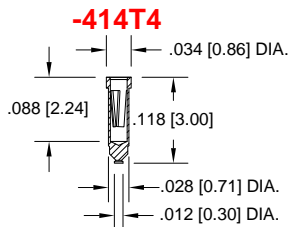
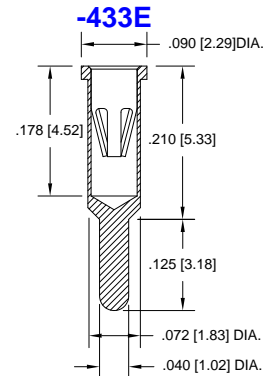
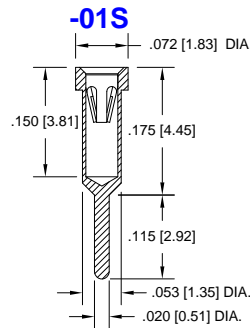
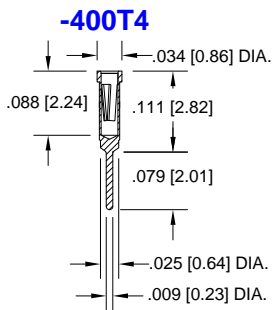

Technical Information

Material:

Insulator: Hi-Temp UL 94V-O
Terminal: Brass, per ASTM-B16
Contact: BeCu, Per ASTM-B194

Plating: RoHS COMPLIANT

R15 TERMINAL: GOLD / CONTACT: GOLD

R17 TERMINAL: TIN / CONTACT: GOLD

OTHER PLATINGS AVAILABLE

Terminal Acceptance and Forces

Thru Hole Terminals				Surface Mount Terminals			
Thru Hole Terminal	Accepts Pin Diameter	Insertion Force	Withdrawal Force	Surface Mount Terminal	Accepts Pin Diameter	Insertion Force	Withdrawal Force
-01S	Ø.018 [Ø0.46]	9.0 oz Avg.	2.0 oz Min	-93S	Ø.018 [Ø0.46]	9.0 oz Avg.	2.0 oz Min
-433E	Ø.040 [Ø1.02]	36.0 oz Max	3.9 oz Min	-285E	Ø.040 [Ø1.02]	36.0 oz Max	3.9 oz Min
-400T4	Ø.012 [Ø1.52]	1.1 oz Max	0.3 oz Min	-414T4	Ø.012 [Ø1.52]	1.1 oz Max	0.3 oz Min

MOUNTING OPTIONS

